HOGGI[®]



SWINGBO VTi XL User manual

en

1	Model identification & basic configuration	4
1.1	Model identification	4
1.2	Basic configuration	4
1.3	Environmental conditions	4
2	Common information	5
2.1	Preface	5
2.2	Application	5
2.3	Declaration of conformity	5
2.4	Terms of warranty	5
2.5	Servicing and repairs	5
2.6	Duty to inform serious cases	5
2.7	Product safety / product recalls	5
3	Safety instructions	6
3.1	Meaning of symbols	6
3.2	Common safety instructions	6
4	Delivery and Preparing for use	9
5	Adjusting and adaptation possibilities	13
4.1	Wheel lock (wheel lock lever integrated in wheel guards)	13
4.2	Seat width / seat height / camber	14
4.3	Seat depth	14
4.4	Backrest height (backrest panel trough shaped)	15
4.5	Backrest height (backrest panel angle- and height adjustable)	15
4.6	Decline (backrest panel trough shaped)	15
4.7	Decline (backrest panel angle- and height adjustable)	15
4.8	Active degree	15
4.9	Tilt	16
4.10	Height adjustment of push-bar	16
4.11	Height- and angle adjustment of push-handle	16
4.12	Anti tip	17
4.13	Detaching rear wheels with quickrelease	17
4.14	Pneumatic tyres / PU-tyres	18
4.15	Hand rims	18
4.16	Drum brakes	19
6	Accessories	20
6.1	Seat panel	20
6.2	Backrest (backrest panel angle- and height adjustable)	20
6.3	Backrest (backrest panel trough shaped)	20
6.4	Foot rest hanger 90°	20
6.5	Knee angle system (angle adjustable)	21
6.6	Footrest angle adjustment	21
6.7	Footrest lock (optional)	21
6.8	Footrest	21
6.9	Footrest with heel stop	22
6.10	Single foot rest hanger (with two single footplates in boat shape)	22
6.11	Lower leg length	22
6.12	Seat cushion	22
6.13	Backrest cushion	22
6.14	Spoke guards	23
6.15	Headrest „standard“: with cushion	23
6.16	Headrest bracket „universal“	23
6.17	Headrest with occiput upholstery	23
6.18	Trunk supports	24

6.19	Chest-/thoracic support	24
6.20	Armrests with PU pads	24
6.21	Armrests with tilt balancing	24
6.22	Therapy tray	25
6.23	Lap belt	25
6.24	4-point lap belt	25
6.25	Ankle hugger	26
6.26	Hip pads	26
6.27	Abduction block	26
7	Transport	26
7.1	In the trunk (luggage space) of a car	27
7.2	Using SWINGBO VTi for bus transport	27
7.3	General	27
7.4	Securing the wheelchair during bus transport	27
7.5	Buckle up the wheelchair passenger	28
7.6	Transfer - getting into or out of the wheelchair	30
7.7	Anti-tippers to override steps	31
8	Storage	31
9	Recycling and disposal	31
10	Maintenance / Service	32
11	Technical Data	33

1 Model identification

1.1 Model identification

(The label of **SWINGBO VTi XL** is placed on the axle tube)

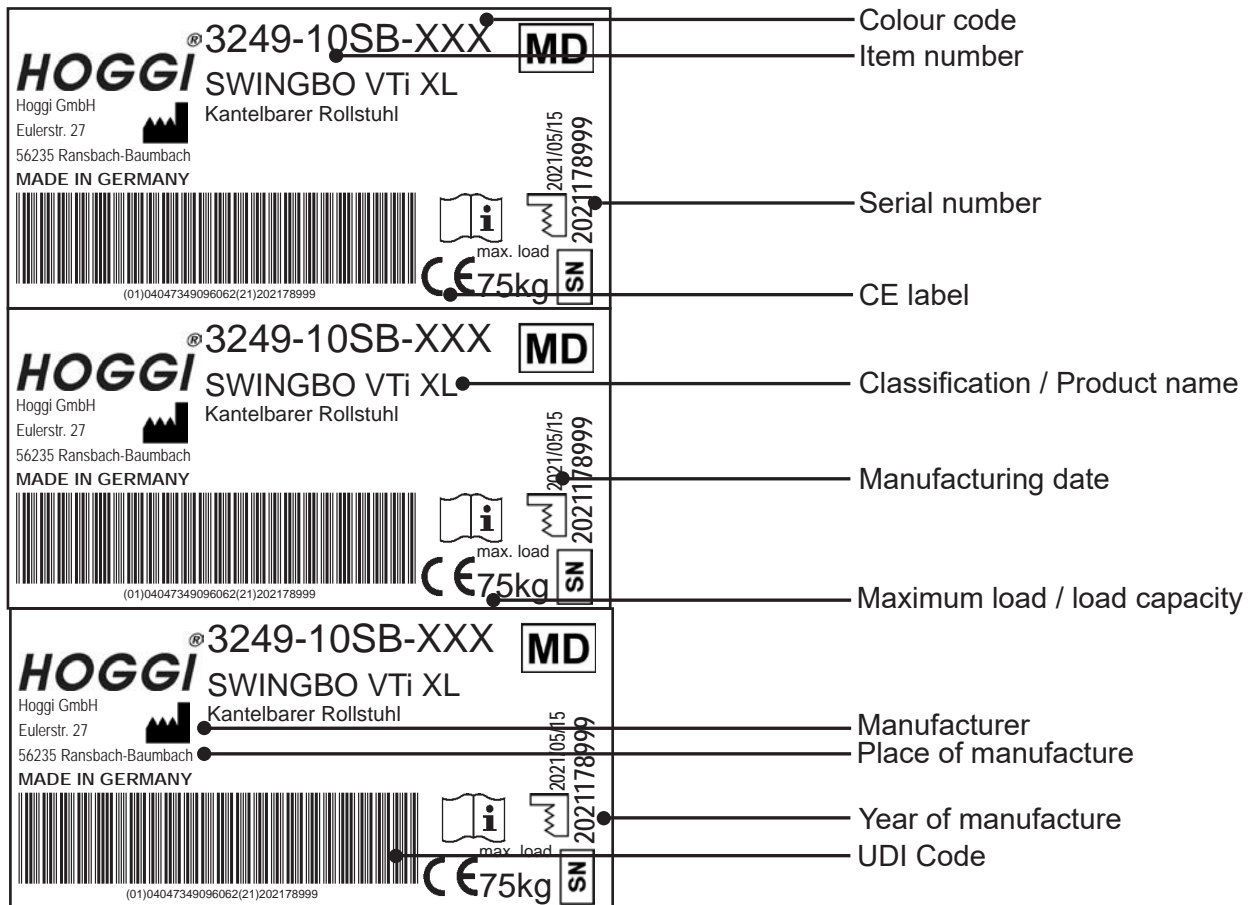

1.2 Basic configuration

- Aluminium rigid frame with centre of gravity tilt in space
- Wheel base adjustable in 2,5 cm steps
- Wheel locks integrated in side panels
- Double wall rear wheels incl. push rims with light weight
- Adjustable seat height
- Push-handle or push-bar included
- Adjustable tilt in space: -5° to +45°
- Seat depth adjustable by apx. 8 cm
- Choice of seat widths 36, 40, 44 cm
- Maximum load 75 kg
- tires, detachable by quick release axles

1.3 Environmental conditions

Environmental factors such as temperature and humidity can damage the wheelchair. The manufacturer recommends not condensing the **SWINGBO VTi** at ambient temperatures between -20 ° C and + 40 ° C and a humidity of 5 to 100%.

Caution: Prolonged exposure to the sun may cause parts of the wheelchair to become hot. Be sure to!

2 Common Information

2.1 Preface

Thank you for selecting the **SWINGBO-VTi** wheelchair. We have designed this high-quality product to make your life safer and easier, and we've included this manual to help you use and care for it. Please read the following instructions to make sure you use this product as recommended. If you have any further questions, or if you have any problems, please contact your healthcare provider.

We hope that **SWINGBO-VTi** meets your expectations.

The design, as described in these instructions for use, are subject to technical alterations without notice.

2.2 Application

The **SWINGBO-VTi** wheelchair is designed solely for individual indoor and outdoor use by persons who are unable to walk or who have a walking impediment, and can be operated by the patient or by another person.

Assistance may be required due to:

- Paralysis (paraplegia / tetraplegia or tetraparesis)
- Loss of limbs (dysmelia/lower limb amputation)
- Infantile/spastic cerebral palsy
- Spina Bifida
- Muscle and nerve disorders
- Imperfect osteogenesis
- Poliomyelitis

2.3 Declaration of Conformity

HOGGI GmbH as manufacturer with sole responsibility declares that the **SWINGBO VTi** wheelchair as a whole conforms to the basic safety and performance requirements in

accordance with Annex I to Regulation (EU) 2017/745 of the EU Parliament and of the Council.

Applicable harmonized standards have been applied. **SWINGBO VTi** meets the requirements of ISO 7176-8, DIN EN ISO 12182 and DIN EN ISO 12183.

2.4 Terms of Warranty

Warranty applies only when the product is used according to the specified conditions and for the intended purposes, following all manufacturer's recommendations.

The manufacturer is not responsible for damages caused by components and spare parts not approved by the manufacturer.

2.5 Service and Repairs

Service and repairs on the **SWINGBO-VTi** should only be carried out by authorized HOGGI dealers. Should any problems arise, please contact the dealer who supplied your **SWINGBO-VTi**.

Authorized dealers only fit original HOGGI spare parts.

2.6 Duty to inform serious cases

All serious incidents that have occurred in connection with the product must be reported to the manufacturer, the specialist trade and the responsible authority.

2.7 Product safety / product recalls

You can find out about new information on product safety and product recalls from specialist retailers or directly from the manufacturer at **www.hoggi.de**



For Preparing, repair and service, the following tools are required:

Allen wrench, size: 3 mm, 4 mm, 5 mm und 6 mm

Screw wrench, size: 8 mm, 10 mm, 13 mm, 17 mm, 19 mm und 24 mm

3 Safety instructions

3.1 Meaning of symbols



Caution!
Warning of possible danger of accident and injury. Warning of possible technical damage.



Information!
about use of product.



Information!
for service-personnel.



Attention!
Read manual before!

3.2 Common safety instructions



Read manual completely before use!
Familiarize yourself with handling and functions of the wheelchair before use and practice the handling.
You are responsible for the safety of your child. The safety of your child could be affected if you do not follow the instructions of this manual. Nevertheless not all possible circumstances and unpredictable situations can be covered by this manual. Reason, care and circumspection are not features of the product, they are required of persons, who use the wheelchair or attend it. The person, who is using the wheelchair and its accessories should understand all instructions. It must explained to every other person using the wheelchair and its accessories.
If instructions are not clear and further explanations become necessary, or if you have further questions please contact your HOGGI dealer.
Practise with the new wheelchair on even, straightforward terrain first, together with the child. Together with the child, learn how the wheelchair reacts when the centre of gravity shifts; for example on slopes or inclines or when clearing obstacles such as steps and curbs. This should be done only with assistance from another person.
Using an anti-tip is strongly recommended for inexperienced wheelchair users.



Strap in your child at all times, when it is in the wheelchair.



HOGGI points out, that any use beside the typical use can be dangerous. The wheelchair is not suitable for jogging, running, skating or similar activities. Swivelling front wheels tend to wobble at higher speed, which can cause a sudden stop and tip over of the wheelchair. Use the wheelchair only at regular walking speed. Under no circumstances leave the handle bar while pushing and never push the wheelchair away.



The wheel chair should only be used on solid level ground.



Use your wheelchair as intended by the manufacturer. For instance, do not drive into obstacles (including steps, curbs) without braking. Do not „jump“ the chair down from higher surfaces.



To clear obstacles such as steps and curbs, tilt the wheelchair onto the rear wheels (pull it backwards to go up; to descend, slowly lower it forward).

If only one attendant is available when ascending or descending stairs, an incorrectly set anti-tip (if mounted at all) can lead to severe falls. Adjust the anti-tipper so that it does not come in the way of the steps during transport. Afterwards, swing the anti-tipper back to its operational position.



Do not go up or down stairs without the assistance of another person. If devices such as ramps or elevators are available, please use them. Ensure that the anti-tip (if mounted) is outside the danger-area. If wheelchairfriendly access is missing, two attendants must carry the wheelchair over the obstacle.



When ascending slopes or ramps and when crossing obstacles on upward slopes, always lean the wheelchair user's upper body far forward.

When descending slopes, do not drive without braking and reduce your speed. Reduced load on the casters due to centre of gravity shifting can cause the casters to flutter.



If you have to park on a slope, face the wheelchair uphill with the brakes engaged and ensure that the seat is in the upright position. There is a risk that the pushchair might tip over backwards if the seat is the reclined position.



Before leaving the wheelchair and before getting into and out of it, always lock the wheel locks.



It is only allowed for children with a body weight less than 20 kg to stand on the footplate getting into the wheelchair.

For children above 20 kg fold up the footplate before getting into or out of the wheelchair.



Depending on footplate settings and wheelchair geometry, the wheelchair may tip over if the user boards the chair using the footplate. First practise boarding the chair with the child and an attendant who can secure the wheelchair, and modify footplate and seat height settings if the chair has a tendency to tip over. In addition, turn the caster fork to the front prior to using the footplate for getting into the wheelchair; this increases the wheelbase and thereby the wheelchair's stability against tipping.



The effectiveness of the wheel lock and the overall driving quality are dependent on adequate air pressure. With properly inflated rear wheels and even tyre pressure on both sides, your wheelchair is much easier to operate and manoeuvre. Before starting to use your wheelchair, check that the tyres are inflated correctly. The required air pressure is printed on the side of the tyre. For rear wheels, it should be at least 6 bar.



All brakes acting on the tyres do not serve as service brake but are only designed as parking brake (wheel lock). The wheel locks must not be used as driving brakes for slowing down the wheelchair, as in extreme cases, the abrupt stopping of the wheelchair can lead to falls.



Please keep packaging material away from children. Plastic packaging presents the danger of suffocation.



Disposal of waste: The packaging material as far as metal, aluminium and plastic parts can be recycled. The recycling must be operated according to the national and legal terms.



Never leave your child unattended in the wheelchair even when they are strapped in and the brakes engaged.



In the dark, the user should wear light clothing or clothing with reflectors in order to improve visibility. Ensure that the reflectors installed on the sides and rear of the wheelchair are easily visible. We also recommend installing active illumination.



Extreme settings (e.g. shortest wheelbase and seat in the backmost position) combined with an unfavourable body posture can cause the wheelchair to tip even on level ground.



Static stability is $>10,5^\circ$ inclination.
Attaching heavy bags or other weight to the push handles can adversely affect stability.



Adjustments with a high active degree demand a practised driver and the use of an anti tip.



Under no conditions should the anti-tip(s) assume the function of transport wheels, for example to transport a person in the wheelchair with the rear wheels removed. The anti tips must audibly lock in place, before it is able to bear loads.
Firm seating must be verified by the user or by an attendant.



The **SWINGBO-VTi** is only intended to carry one child at a time.
The maximum load for the **SWINGBO-VTi** is 60 kg.



Accessories and add-ons reduce the maximum load proportionately.



We recommend that, wherever and whenever possible, users transfer to the seats installed in the motor vehicle and use the corresponding vehicle restraint systems, because this is the only way to ensure optimum protection of the passengers in case of an accident.
Your SWINGBO-VTi is admitted for use as a seat in a motor vehicle.



Be careful in case of extreme temperatures. The wheelchair can heat up significantly when in the sun or in the sauna. In extreme cold, there is a risk of hypothermia.
Slowing down from high speeds or when descending longer slopes tends to heat up the hands and fingers, especially if using aluminium push rings. When using the wheelchair outdoors, leather gloves should be worn. Gloves provide the wheelchair user with a better grip and protect his or her fingers from dirt and hot metal.



Always make sure that the quick-release axles are correctly set on the rear wheel. It must not be possible to remove the rear wheel unless the button on the quick-release axle is pushed.



The assembly of a seat shell is only permitted within the specified seating area.
The manufacturer of that new product combination has to test the stability and the adherence of the maximum load before commissioning.



Whenever you change any settings on the wheelchair, make sure that you firmly tighten any screws that have been loosened.



Neither seat nor backrest height may be exceeded.



Don't use the footrest to get in or out of the wheelchair!



4 Delivery and preparing for use

Your **SWINGBO-VTi** wheelchair will normally be supplied completely mounted with detached or folded push-bar / push-handle and with removed front castors and rear wheels. (1).

The original package contains the following parts:

- Wheel chair with detached or folded push-bar / push-handle
- Rear wheels and quick-release axles unmounted
- Front castors already mounted in the front castor forks
- Additional accessories as ordered
- Instructions and list of tools required



Please remove the transport packaging carefully.

To prepare the wheelchair for use please proceed as follows:

- Grip the head of the quick-release axle as illustrated (2) and press the release knob.
- Whilst pressing the release knob, position the quick-release axle into the rear wheel bearing (3).



- Place the wheelchair onto the front castors and lift the wheelchair by holding the rear of the seat (4).
- Insert the rear wheel and the quick-release axle into the axle housing. Hold the spokes (4) close to the wheel hub and press the release knob with your thumb. The rear wheel can then be easily slid into position.
- Ensure that the quick-release axle is securely fixed in the axle housing.



CAUTION!

Push each rear wheel to check that each quick-release axle is safely located.



If your **SWINGBO-VTi** is supplied with a foldable backrest it is possible that it is folded for the transport.

- Pull the backrest at the cross tube into the upstanding position (5).



Whenever you change any settings on the wheelchair, make sure that you firmly tighten any screws that have been loosened.

If your **SWINGBO-VTi** is supplied with an angle- and height adjustable backrest it is possible that it is in hinged position for the transport.

- Pull the backrest as shown to the back (6).



- Pull the bowden cable as shown (7).
- Let the bolt lock in place in the desired backrest angle position.



CAUTION!
Check with a sharp push on the backrest that the bolt is securely located.



The anti tip supports are pre-assembled (8). Stick the anti tip tubes into the particular support. Press the snap button and choose the desired length position (please see close up picture).



SWINGBO-VTi is equipped with two anti-tippers. The image (9) shows the „active“ position.



To flip up:

- Activate the bowden cable with your foot as shown.
- Pull your foot easily to the back.

The tubes of the anti tippers will flip up automatically.





- Move the tubes with your foot to the top until the bolt clicks into the „passive“ position.

To flip down:

- Activate the bowden cable with your foot.
- Pull your foot easily to the front.

The tubes of the anti tippers will flip down automatically.



- Move the tubes with your foot to the bottom until the bolt clicks into the „active“ position.



CAUTION!

By tipping the wheelchair carefully backwards onto the anti-tippers, check that they are securely located.

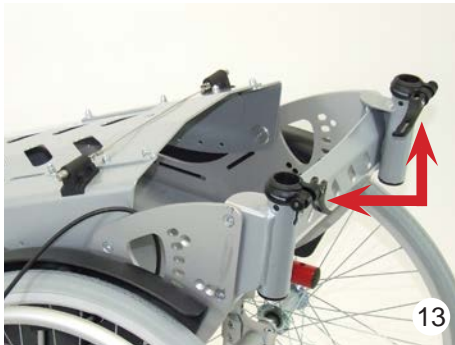

If your **SWINGBO-VTi** is supplied with a detachable push -bar / pushhandle please proceed as follows:

- Open the cam lever on both sides (13).



- Place the push bar / push -handle down into their locating brackets (14).



- Press in the spring button and slide the push bar / push-handle downwards fully into its bracket, until it clicks into position (15).

- Close the cam lever on both sides (16).



When the cam lever is open, its tension can be altered by adjusting the nut (17).



CAUTION!

The maximum adjustment of the push bar is predetermined. Under no circumstances should they be adjusted beyond these limits. Press on the push bar to ensure that they are securely located.



If your SWINGBO-VTi wheelchair is supplied with seat or back upholstery from HOGGI, please proceed as follows:

- Slide the upholstered seat cushion under the backrest and lay the seat cushion on the seat surface as illustrated (18).
- Fasten the front flaps on the seat panel as shown in illustration (18).



- Fasten the flap of the seat cushion to the back edge of the seat surface (19).



If your SWINGBO-VTi wheelchair is supplied with an angle and height adjustable backrest, please proceed as follows:

- Fasten the side cushioning on the inner side of the backrest. It should cover the contour of the backrest (20).





- Fix the side cushioning also with the press button (21).



- Pull the back cushion from top to bottom on the backrest panel.
- Press the cushion firmly on the backrest panel.



5 Adjusting and adaptation possibilities

5.1 Wheel lock (knee lever wheel locks, mounted on the frame)

- Press the brake lever below to lock the wheel lock (23).



CAUTION!

All brakes acting on the tires do not serve as a slow down brake but are only designed as a parking brake (wheel lock). The wheel locks must not be used as driving brakes for slowing down the wheelchair, as in extreme cases, the abrupt stopping of the wheelchair can lead to falls.



The brake shoe presses on the tires and grips it tightly. The brake shoe is, therefore, at a 90° angle to its holder (24). The brake shoe should overlap 3-5 mm to the middle of the wheel (24).



CAUTION!

The effectiveness of the wheel lock are dependent on adequate air pressure. Before starting to use your wheelchair, check that the tires are inflated correctly. The required air pressure is printed on the side of the tires. For rear wheels, it should be at least 6 bar



- To release the wheel lock pull the brake lever upwards (25).

When the wheel lock is released the brake shoe should be 12-15 mm from the wheel (26 A).

This distance can be adjusted by the adjustment screw (26 B) or by displacing the wheel lock on the mounting clamp (24 A).

The wheel locks should only be adjusted by a technician.

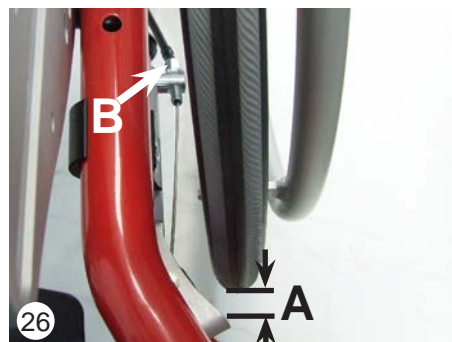

5.2 Seat width / Seat height / Camber

The SWINGBO-VTi is available in four seat widths (24, 26, 28, 30, 32 and 36 cm).

The seat width gets measured between the wheel guards and it depends on the cross tubes (27).

The SWINGBO-VTi wheelchair will be built in accordance with the customer's order. It is possible for the technician to modify the wheelchair with a different seat width.

The seat height is dependent on the chosen rear wheels and front castors, as well as on the height of the rear axle and the position of the front castors in the front castor forks(28).

The SWINGBO-VTi wheelchair was built in accordance with the customer's order. It is possible for the technician to modify the wheelchair with a different camber.

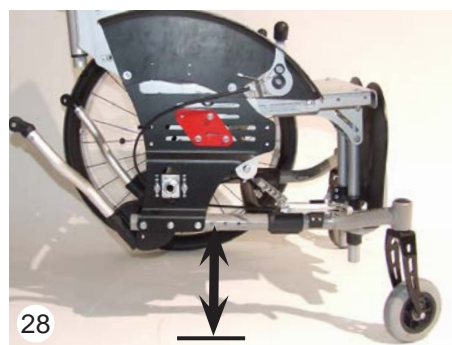

The SWINGBO -VTi wheelchair can be supplied with rear wheels inclined (camber) 3° (not pictured here), (camber) 6° (29, left) or 9° (29, right) from the vertical.

The SWINGBO-VTi wheelchair was built in accordance with the customer's order. It is possible for the technician to modify the wheelchair with a different camber.



5.3 Seat depth

- To adjust the seat depth remove the seat cushion first.
- Loosen the four screws under the seat and adjust the seat depth by sliding the seat to the required position.

To get the maximum stability the four screws should be positioned with a distance (to each other) as far as possible.

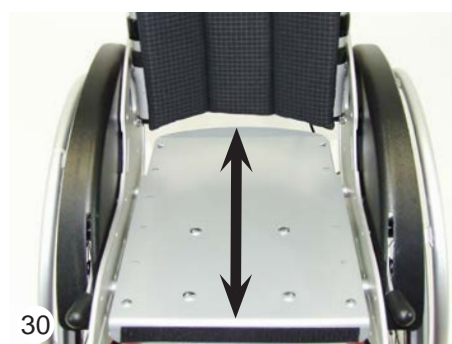

Whenever you change any settings on the wheelchair, make sure that you firmly tighten any screws that have been loosened.



5.4 Backrest height (backrest panel trough shaped and height adjustable)

If your SWINGBO-VTi wheelchair is supplied with a trough shaped, 2-parts, height adjustable backrest, please proceed as follows:

- To adjust the seat depth remove the backrest cushion first.
- Loosen the four screws on the backrest panel and adjust the backrest height by sliding the panel to the required position (31).



5.5 Backrest height

If your SWINGBO-VTi wheelchair is supplied with an angle- and height adjustable backrest please proceed as follows:

- Loosen the four screws on the backrest panel and adjust the backrest height by sliding the panel to the required position (32).



Whenever you change any settings on the wheelchair, make sure that you firmly tighten any screws that have been loosened.



5.6 Backrest recline (backrest panel trough shaped and height adjustable)

- Remove the rear wheel and the spoke guard on both sides.
- Loosen and remove the marked bolting on both sides.
- Decline the backrest and choose one of the five backrest declines.
- Firmly tighten all boltings.



5.7 Backrest recline • Secure with one hand the backrest panel on top as shown (34).

- Pull the bowden cable until the bolts get out of the housings.
- Choose the desired backrest position.
- Let the bolts click into the desired position.



CAUTION!
Check with a sharp push on the backrest to ensure that the bolt is securely located.



5.8 Active degree

The active degree describes the relation of the backrest position to the rear wheels. The more the backrest is positioned to the rear axle, the more active SWINGBO-VTi can be driven. (e.g. lifting of the front wheels). That means contrary a safer driving position if the adjustment is set above or in front of the rear axle.



CAUTION!
Adjustments with a high active degree demand a practised driver and the use of an anti tip. The SWINGBO-VTi was built in accordance with the customer's order. It is possible for the dealer to modify the active degree.

- After loosening the three marked M6 nuts on both sides of the VTi the seat unit can be slid stepless into the desired position.
- Regard that the choosen position is identic on both sides.
- Firmly tighten all boltings.



Make sure that you firmly tighten any screws that have been loosened.

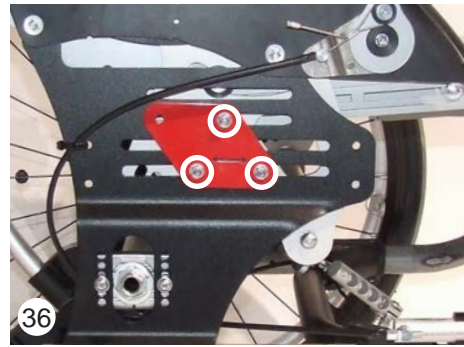

5.9 Tilt

- Lock both wheel locks.
- Pull the release handle (39) until the locking mechanism is fully disengaged.

By using the push-bar or push-handles, the seat unit can be adjusted to any angle between -5° and $+45^{\circ}$.

Set the required seat angle and allow the bolt to lock in the required position.



CAUTION!
Push sharply on the push-bar or push-handle to ensure that the bolt is securely located.



5.10 Height adjustment of the push-bar

The ratchet joint on the push-bar allows them to be adjusted to a comfortable height for the attendant.

By pressing in the knobs on both ratchet joints (39), the push bar can be turned to the required position.



If your SWINGBO-VTi wheelchair is supplied with a detachable pushbar it is possible to adjust the height of the push-bar after loosening the cam levers (40).

But it is advisable to adjust the height about max. 5 cm, otherwise the tilt function can be limited.

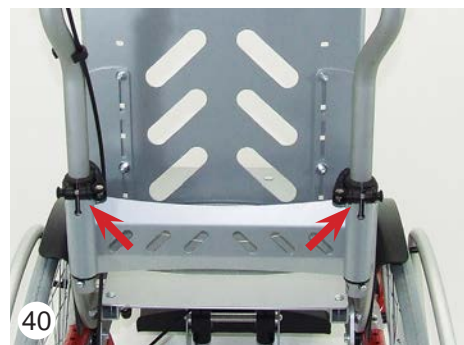



5.11 Height adjustment of the push-handles

The push-handles are height and angle adjustable.



5.12 Anti tip

- The angle of the anti tip can be adjusted by loosening the marked screw (42).



Picture 43 shows the position of the anti tip. The anti tip should be adjusted that it is 2-3 cm above the ground.

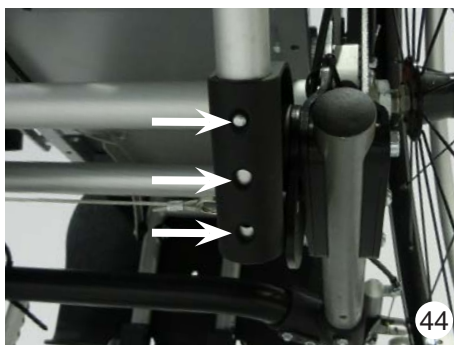

After pressing the snap button the length of the tubes can be adjusted in three positions (with respectively 2,5 cm distance).



5.13 Detaching the rear wheels with quick-release axles

The rear wheels are removed by means of a quick-release mechanism. This reduces the volume of the wheelchair for transport:

- Grip the spokes close to the wheel hub and, with the thumb, press the release knob of the quick-release axle.
- Pull the rear wheel with the quick-release axle out of the axle housing.

- To avoid a risk of snagging, it may be preferable to withdraw the quick-release axles from the rear wheels.
- To re-assemble the rear wheels refer to section 3 “Delivery and preparing for use”.



CAUTION!
Push sharply on each rear wheel to ensure that the quickrelease axles are securely located.



5.14 Pneumatic tires / PU-tires

The rear wheels can be supplied with pneumatic tires (48, left). The car type valves enable the tyres to be checked or inflated at any petrol station or by means of a suitable pump, supplying a minimum 6 bar pressure.

Check the maximum tire pressure, which is indicated on the tire.



The drive wheels can also be supplied with solid PU-tyres (48, right).



5.15 Hand rims

Hand rims can be supplied in aluminium (49, right) or stainless steel (49, left) according to preference.



Hand rims can be supplied with a standard diameter (50, left) or with a larger diameter (50, right). These are called respectively hand rims “standard” or hand rims “high”.



The SWINGBO-VTi wheelchair was built in accordance with the customer’s order. It is possible for the retailer to fit alternative push rims.



All hand rims can be mounted close to the rear wheel or a little further apart. A future modification is possible again.



5.16 Drum brakes

In addition to wheel lock and wheel lock (lever integrated in wheel guards), the SWINGBO-VTi wheelchair can be fitted with drum brakes.

The drum brakes are activated from the push-bar or push-handles.



Each drum brake is operated by a brake lever (53).



- To apply the drum brake squeeze the brake lever (54).
- With the finger tips press the rocking catch, until it locks with a click and release the brake handle.

When the brake lever is squeezed again, the rocking catch is unlocked and the drum brake can be released.



The brake force can be adjusted by the adjustment screw (55).

6 Accessories

All accessories not installed by the manufacturer must be installed by trained technicians.

The following notes on installation are for your information but should be performed by trained technicians.



Straps on accessories are usually extra long to accommodate every option. Shorten excess strap ends on accessories so that they can not be trapped. To prevent strap ends from fraying the cut ends can be melted together with a flame (eg. lighter).

6.1 Seat panel

The SWINGBO-VTi wheelchair was built in accordance with the customer's order.

Function and adjustment of the seat panel are described in 4.2 and 4.3.



6.2 Backrest (angle- and height adjustable)

The SWINGBO-VTi wheelchair was built in accordance with the customer's order.

Function and attachment of the backrest panels are described in 4.5 and 4.7.



6.3 Backrest (backrest panel trough shaped and height adjustable)

The SWINGBO-VTi wheelchair was built in accordance with the customer's order.

Function and attachment of the backrest panels are described in 4.4 and 4.6.



6.4 Foot rest hanger 90° (knee angle)

Fix mounted foot rest hanger 90° (59) available for different lower leg lengths:

LLL short: 16- 37 cm

LLL long: 16 - 40 cm





6.5 Knee angle system, angle adjustable

Fix mounted knee angle system, continuously angle adjustable from 85 - 160° (60).

LLL short: 19 - 37 cm

LLL long: 19 - 40 cm

60



6.6 Foot rest angle adjustment

The foot rest can be folded upwards.



To get in the wheelchair the footrest must be always folded upwards.

The position of the foot rest can be adjusted by loosening the four screws on the foot rest bracket (61).

61

This alters the location of the foot rest and, therefore, also the foot rest angle.



The angle of the foot rest can be adjusted from approximately 80° to 100° (62).

- Afterwards, retighten the screws securely.



Whenever you change any settings on the wheelchair, make sure that you firmly tighten any screws that have been loosened.

62

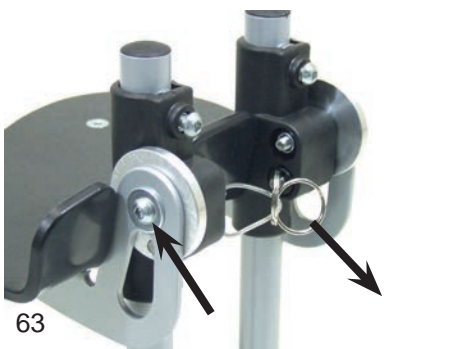

6.7 Foot rest lock (optional)

The foot rest bracket can be supplied additionally with a locking device. When adjusting the foot rest angle, the locking device must also be adjusted, by loosening the screws on the right and the left side.

By pulling the release ring, the foot rest can be folded upwards. When the foot rest is folded down, it will automatically lock into position.

63



All four screws on the footrest must be fixed.



6.8 Foot rest

Foot rest to position the feet (64).

64

6.9 Foot rest with heel stop

Fußbrett zum Positionieren der Füße mit zusätzlicher Fersenkante, die ein Herunterrutschen der Füße nach hinten verhindert (65).



65

6.10 Single foot rest hanger (with two single footplates in boat shape)

- Function and attachment of the knee angle are described in 5.5.
- Function and attachment of the foot rest angle are described in 5.6.
- Function and attachment of the foot rest lock are described in 5.7.
- Function and attachment of the lower leg length are described in 5.11 but it is necessary (if your wheelchair is equipped with the single foot

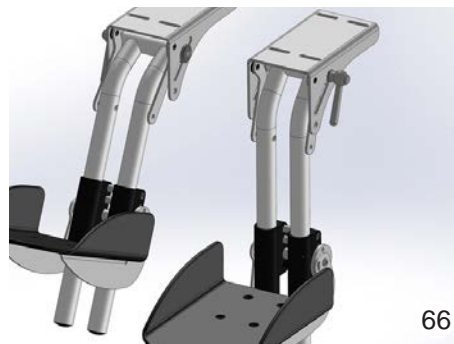

66

6.11 Lower leg length

After releasing both clamping screws on the footboard bracket (67) it is possible to adjust the required lower leg length continuously:

- Retighten the clamping screws securely.



Whenever you change any settings on the wheelchair, make sure that you firmly tighten any screws that have been loosened.

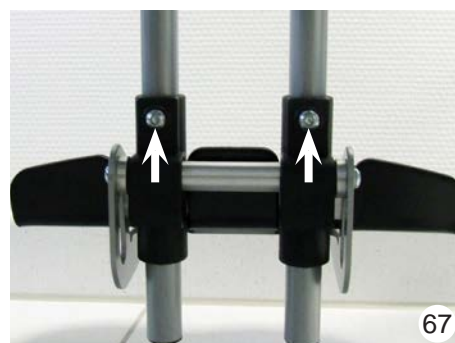

67

6.12 Seat cushion

The HOGGI seat cushion is 3 cm thick and is foam filled. The cushion cover is washable and can be unzipped to remove the foam pad (68).



68

6.13 Backrest cushion

The HOGGI back cushion is 2,5 cm thick and is foam filled. The cushion cover is washable and can be unzipped to remove the foam pad (69).

The side pads also belong to the backrest cushion (only for the angle- and height adjustable backrest). See close up picture.

In order to adjust the height of the backrest the back cushion and side pads must be removed first.



69



6.14 Spoke guards

The spoke guards prevent the child's fingers from being trapped in the spokes.

The transparent spoke guards can be painted by the child or have decorative stickers applied. (70).

Please visit www.hoggi.de to see our coloured variations of spoke guards! Or order our spoke guard brochure!



6.15 Headrest standard with cushion

This headrest is only lightly contoured and serves as a contact surface for the back of the head.

This headrest can be mounted on both backrests (71).



After loosening the four screws the headrest can be adjusted in the height (72).

The cover can be removed for cleaning.



Whenever you change any settings on the wheelchair, make sure that you firmly tighten any screws that have been loosened.



6.16 Universal headrest bracket

The bracket for the headrest can be mounted on both backrests (73).

Release the clamping lever to adjust the height of the headrest.



Whenever you change any settings on the wheelchair, make sure that you firmly tighten any screws that have been loosened.



6.17 Headrest with occiput upholstery

This headrest can be adjusted both in height and in angle.

The metal frame under the upholstery can be supplied to suit head size

The cover can be removed for cleaning.

6.18 Trunk supports

The trunk supports are separately adjustable and the size of the pads is approx. 33 - 43 cm (75).



75

6.19 Chest-/ thoracic support

The chest-/ thoracic support are adjustable in the height and the breadth as well as in 2 angles.

- To open the chest-/ thoracic support use the connectors.
- Press the connectors at the marked position (A).
- At the marked buckles (B) it is possible to fix or rather loosen the chest-/ thoracic support.

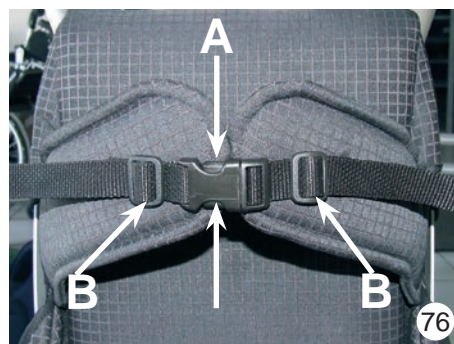

76

Illustration 77 shows the chest-/ thoracic support adjusted in two different angles.

The SWINGBO-VTi wheelchair was built in accordance with the customer's order. It is possible for the retailer to convert the chest-/ thoracic support to other angles.



77

6.20 Armrests with PU-pads

After loosening and removing the marked screws the height of the armrests is adjustable (78).



Whenever you change any settings on the wheelchair, make sure that you firmly tighten any screws that have been loosened.

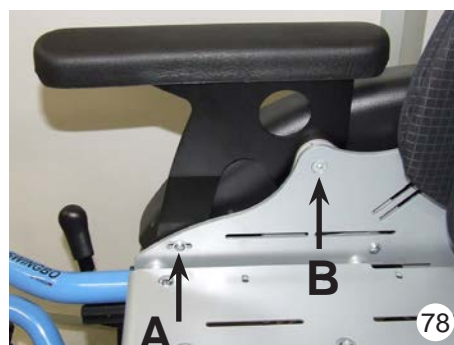

78

6.21 Armrests with tilt balancing

- Loose and remove the marked bolting A .
- Loose the bolting B.
- Choose your desired height position.
- Insert bolting A and tighten bolting B.



Whenever you change any settings on the wheelchair, make sure that you firmly tighten any screws that have been loosened.

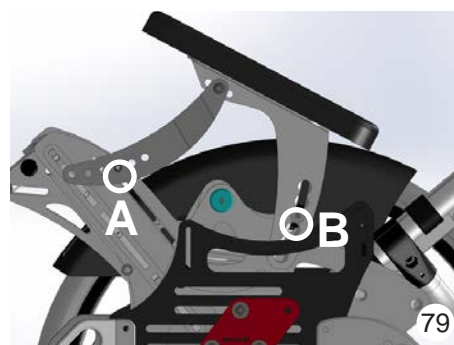

79



6.22 Therapy tray

The therapy tray can be mounted with terminal strips on the armrests.
The terminal strips are preset to the distance of the armrests.

- Loose the knurled nut and press the clamp.
- Position the therapy tray on the armrests.
- Tighten the knurled nut.



6.23 Lap belt

At the end of the belt are pre-assembled buckles.

- Lead the end of the lap belt as shown, so that the belt passes only once through the buckle.

The length of the free belt end causes the lap belt length.

- Lead the belt end through the slotted holes on the left and right side of the backrest base (81).



- Lead the free belt end through the buckle once again (82).



Open the lap belt by pressing the red button (83).

When the lap belt is fastened, fine adjustment can be made by pulling one free end of the belt.



6.24 4-point-harness

The 4-point harness should be installed by authorized dealers or trained technicians.

Take off the seat upholstery first and mount the buckles at the slotted holes.

The lap belt ends and the tension belts get mounted and preset as described in 5.23.

Open the lap belt by pressing the connectors.

At the belt buckle the lap belt can be readjusted by adducting the lap ends (fine tuning).



6.25 Ankle hugger

By using the ankle straps feet and ankles can be comfortably positioned. The ankle straps are passed through the rings on the footrest. This holds the heels against the raised heel plate at the rear of the footrest.

The ankle straps can be adjusted and then fastened with Velcro.

The fastening should always be on the outside (86).



6.26 Hip supports

After loosening the particular screws it is possible to adjust length, depth and width of the hip supports.



6.27 Abduction block, swing away and detachable

The abduction block guides the thighs apart.

By activating of the marked activator you can swing away or detach the abduction block for an easy entrance or exit .



7 Transport

7.1 In the trunk (luggage space) of a car

The SWINGBO-VTi wheelchair can according to size and specification, be transported as one unit, with folded down backrest and folded up foot rest. (89).





For convenience of handling it may be preferable to partially dismantle the wheelchair into a few main components.

To achieve the most compact folding package fold the backrest and foot rest but remove the rear wheels, the anti tip assemblies and the push bar/ push handles (90).



7.2 Using SWINGBO-VTi for bus transport



CAUTION!

We recommend that, wherever and whenever possible, users transfer to the seats installed in the motor vehicle and use the corresponding vehicle restraint systems, because this is the only way to ensure optimum protection of the passengers in case of an accident.

Your SWINGBO-VTi is admitted for use as a seat in a motor vehicle.

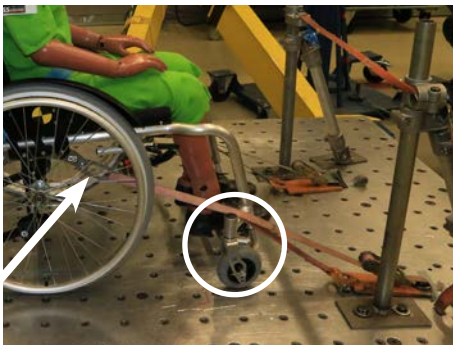

7.3 General

- Check that your wheelchair is suitable for a crash test.
- Check that the vehicle is equipped and compatible for transporting your wheelchair.
- Pay attention to the correct course of the belt (see marking)
- There should also be enough space for safe transport.
- During transport ensure an upright sitting position.



Please note that improper use of a wheelchair in a wheeled ambulance can be dangerous beyond typical use. Failure to follow this advice will result in serious injury or death.

7.4 Securing the wheelchair during bus transport

We recommend that, wherever and whenever possible users transfer to the seats installed in the motor vehicle and use the corresponding vehicle restraint systems, because this is the only way to ensure optimum protection of the passengers in case of an accident. **SWINGBO VTi** was successfully tested in accordance with ISO 7176-19 (Crash Test).

It is, however, possible to use **SWINGBO VTi** as a seat in a motor vehicle, if our "Tie down Kit" as well as appropriate restraint systems are used. Your **SWINGBO VTi** is admitted for use as a seat in a motor vehicle yet.

- 1) If the user finds itself in the rehab pushchair, the rehab pushchair has to be positioned forward and has to be fixed with the fastening and safety belts according to the instruction for use of the restraint system manufacturer (fastening belts referred to WTORS need to fulfil the requirements of ISO 10542 or SAE J2249).
- 2) The wheelchair has not been tested for transportation in another position. The transportation in a lateral directed position for instance is not allowed at all.
- 3) Depending on the size of the pushchair the maneuverability can be impaired, so that the turning of the pushchair is not or only partially possible, to position the stroller forward in the direction of travel.

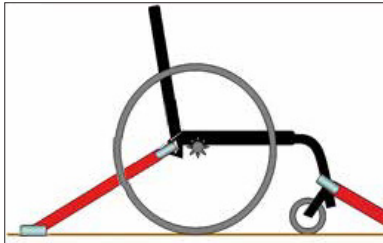

- 4) The buggy has to be fixed with a restraint system referred to ISO 10542 or SAE J2249 with fixed belts in the front and adjustable belts in the back. Usually this concerns snap hooks/ s-shaped hooks as well as plug closures. The restraint systems usually consist of 4 single belts, which have to be attached to the 4 edges of the pushchair. The attachment points of the pushchair restraint systems are marked with the international hook symbol.
- 5) The wheelchair may also be supplemented for transport with other positioning and fixation systems. However, these are not a substitute for passenger and rehab pushchair restraint systems and may limit user comfort. The accommodation of a wheelchair in a vehicle using anchored belts was rated as „poor“ according to the test methods of ISO 7176-19 Appendix D.



SWINGBO VTi may only be used forward in the direction of travel.



The wheelchair was dynamically tested in the direction of travel and the dummy was there fastened with lap belt and shoulder strap.



In order to reduce the risk of injury to vehicle occupants, tools that are not specifically designed for crash safety, should be removed and stored separately in the vehicle safely such. eg crutches, loose pillows, therapy tables etc.



Without consulting the manufacturer, no changes may be made or replaced at the points of attachment of the wheelchair or to components of the chassis and frame. Failure to comply with these requirements, the wheelchair may not be transported in vehicles..

7.5 Buckling the wheelchair passenger



The user has to be buckled up with the lap belt as well as the shoulder belt.



Shoulder and lap belts should be used to minimize and / or avoid potential injury from impact on vehicle components.

- 1) The person executing the attachment should be trained in the handling of the system.
- 2) Before transportation the following adjustments of the rehab buggy have to be carried out:
 - Seat: 0° - 5°
 - Backrest: 90° - 100°
 - Footrest: 90°
- 3) The angle between lap belt and horizontal has to be 30° - 75°. An angle close to 75° is preferable.

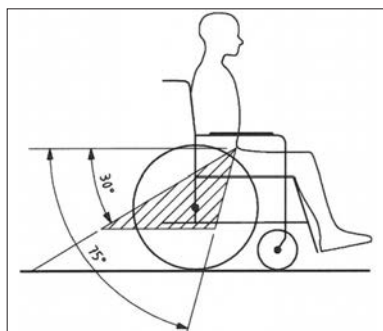
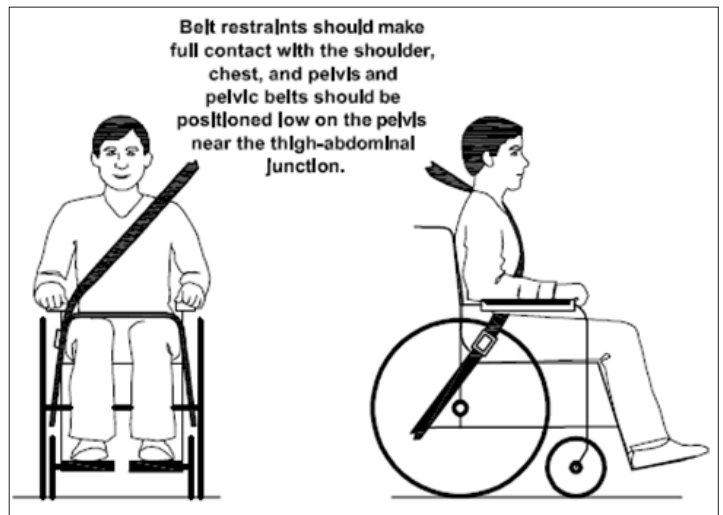

4) The shoulder belt has to run across to chest and shoulder. The belt may not but at the neck and may not be attached loose from the shoulder.



The lap belt and the shoulder belt must be flat and as tight as possible against the body and must not be damaged by components such as e.g. Armrests or wheels are kept away from the body and must not restrict user comfort.

5) The belt strap may not be twisted.



As far as possible all additives should be detached and stored securely:
 • crutches, loose cushions and therapy trays.

6) The user's head should be additionally secured by a separate and permanently mounted headrest in the bus.



You should not rely on the occupant restraint systems unless they are marked in accordance with the requirements of ISO 7176-19: 2008.

7) During transport, the drum brake must not be tightened.

8) Please lock the manual brake firmly.



Care should be taken that the occupant restraint is positioned so that in the event of an accident, the release button is not triggered by pushchair components and results in unintentional opening of the seat belts.

9) Remember, however: In the event of a traffic accident, the risk of injury can only be minimized and not ruled out, even if the passenger and rehab pushchair restraint systems are used correctly.



Before reusing the pushchair after a collision or an accident with a bus, the pushchair may no longer be used for transport in a bus until it has been checked for possible damage by authorized personnel and then released again.



If you have questions about our products and transport safety devices for wheelchairs, we or your specialist dealer will be happy to help.



Attachment points, front according to ISO 7176-19



Attachment points, rear according to ISO 7176-19 for lap belt



Attachment points, rear according to ISO 7176-19

7.6 Transfer getting into or out of the wheelchair

ATTENTION!

- Always lock the wheel locks before getting into or out of the wheelchair.
- First practise boarding the chair with the child and an attendant who can secure the wheelchair, and modify footplate and seat height settings if the chair has a tendency to tip over.
- Increase the safety against tipping by turning the steering wheel fork forwards (this increases the wheelbase).



For adolescents it can be advantageous, according to age, weight and ability, to make a transfer over the side of the wheelchair. Firstly position the wheelchair at an angle of 45° to the seat or wheelchair, from which a transfer is to be made.

Apply the parking brake.

During the transfer the seat surface, the backrest surface, the push rims or briefly the side of the seat can be used for support.

The transfer should be practiced with a helper, until it can be accomplished safely. The transfer should be carried out in one movement. Afterwards, fold down the foot rest and position the feet on it. If necessary correct the seat position.

Finally the parking brake can be released and the wheelchair is ready for use.

Carry out the sequence in reverse when getting out of the wheelchair.





7.7 Anti tippers to override steps

SWINGBO VTi is always equipped with two anti tip units.

Function and attachment of the foot rest lock are described in section „**4 Delivery and preparing for use**“ and in section „**5 Adjusting and adaptation possibilities**“



Caution!

If the overriding of steps are only with the help of another person possible - a mounted or active anti tip can lead to falls.

Adjust the anti tip so that it can not touch the steps.

After overriding the steps or similar barriers adjust the anti tip again!.



8 Storage

Depending on its size and features, **SWINGBO VTi** can be folded in one piece with the backrest folded in and the footrest folded up to be stored.



Care instructions!

Clean **SWINGBO VTi** thoroughly before storage.
Please observe the care instructions on page 32.



However, there is also the possibility to disassemble the wheelchair with a few simple steps into a few smaller packages.

The smallest size can be achieved by folding in the backrest and footrest and removing the rear wheels.

9 Recycling and disposal

SWINGBO VTi is made from recyclable materials.

The product packaging as well as all metal, aluminum and plastic parts can be recycled.

Disposal must be carried out in accordance with the respective national, statutory regulations.

Please ask the city / municipal administration for local ones waste disposal company.

10 Maintenance

Your SWINGBO-VTi wheelchair is CE approved. The manufacturer herewith guarantees that this medical product as a whole conforms to the basic safety and performance requirements in accordance with Annex I to Regulation (EU) 2017/745 of the EU Parliament and of the Council.

The proper function of the wheelchair, especially of the wheel locks, should be checked before every use.

Safety nuts should be used only once. If they have been loosened several times, they must be replaced.

The items listed in the following table must be checked by the user at the indicated intervals. Failure to carry out these simple checks may lead to problems arising that could invalidate the warranty.

Check	daily before use	weekly	monthly
Function test of the brake/wheel lock	X		
Function test of the anti tip	X		
Function of rear wheels quick-release system	X		
Check stability of footplate		X	
Air pressure (see indication on tyre)	X		
Push rims for damage	X		
Screw connections		X	
Visual inspection for worn parts (e.g. tyres, bearings)			X
Dirt on bearings		X	
Spoke tension of the rear wheelss		X	
Function test of the tilt mechanism			X

Should any defects become obvious, please contact your authorized HOGGI dealer to eliminate them. We also recommend that you have your SWINGBO-VTi serviced by your technician every twelve months.

Instructions for cleaning and maintenance

- Clean all frame components and plastic parts using mild detergents only.
(e.g. Sagrotan)
- Padding parts can be washed at 40 °C. If washed in a washing machine, put them in alinen bag or a pillow case.
- In most cases, wiping with a damp cloth is sufficient..
- Do not use your SWINGBO wheelchair in salt water.
- Keep sand or other particles from damaging the wheel bearings.
- If your wheelchair gets wet, towel-dry it as soon as possible.
- Hair and dirt particles generally accumulate between the caster wheel and fork. This can restrict the caster wheels from rotating smoothly. Remove the caster and thoroughly clean the fork and caster using a mild detergent.
- The rear wheels feature a quick-release system. To keep this system operational, ensure that no dirt adheres to the quick-release axle or axle housing. The quick-release axle should also be lightly lubricated regularly with resin-free sewing machine oil.
- Screw connections should be checked frequently, in particular when beginning to use the wheelchair and after any adjustment. If a screw connection becomes loose repeatedly,consult your dealer.



11 Technical data

Dimensions (cm) and weights (kg)

	24	26	28	30	32	36
Seat width						
Seat depth	26 - 30	26 - 32	26 - 34	28 - 36	30 - 38	34 - 42
Backrest height	33 - 42	35 - 44	37 - 46	39 - 48	42 - 51	46 - 55
Seat angle	-5° to + 45°					
Backrest angle						
Backrest angle- and height adjustable	adjustable in 10° steps from 75° - 115° or 80° - 120°					
Backrest trough shaped	adjustable in 5° steps from 85° - 105°					
Lower leg length	16 cm - 37 cm					
Footrest angle	-10° bis + 10°					
Seat height	36 cm - 47 cm					
Rear wheel diameter	20", 22", 24"					
Front castor diameter	100 mm (4"), 125 mm (5"), 140 mm (5,5")					
Camber	3°, 6° or 9°					
Load caoacity	60 kg					



Attention!
Accessories and add-ons reduce the maximum load proportionately.

HOGGI GmbH
Eulerstraße 27 • 56235 Ransbach-Baumbach • Deutschland
Telefon: (+49) 2623 / 92 499-0 • Telefax: (+49) 2623 / 92 499-99
E-mail: info@hoggi.de • www.hoggi.de