



SUPRA 2.0 Active-wheelchair for kids & adolescents

Basic configuration:

- Foot rest standard
- Adjustable backrest with adjustable back cover
- Rear wheels **HOGGI** light
- **HOGGI** light sports brake
- Seat cover

Crash tested according to ISO 7176-19

Price:

Order form incl. Exportprices (€) Release date 01/2025, valid until revoked

<input type="checkbox"/> Offer		<input type="checkbox"/> Order	
Order number / reference		Date	
Invoice address			
Company		Customer number	
Street		City, Zip code	
E-Mail		Telephone	
Fax			
Delivery address			
Company			
Street		City, Zip code	



Basic configuration

- Powder coated aluminium rigid frame active wheelchair; growing seat depth
- 3 size variations:
 - Size 1: SW 30-34 cm in 2cm-steps, SD 23-39 cm
 - Size 2: SW 30-38 cm in 2cm-steps, SD 24-44 cm
 - Size 3: SW 30-44 cm in 2cm-steps, SD 29-49 cm
- Rear wheels with hollow chamber rims and low-resistance tires incl. handrims, removable via Quick Release Axis
- Wheel camber optional 3°, 6° or 9°
- Backrest angle adjustable from 70° to 115°
- Adjustable back cover or back panel
- Seat height front: 36 cm to 51 cm
- Seat angle: 0° to 10°
- Convertible to other seat widths
- Foot rest: Standard
- Maximum load: 60 kg size 1, 75 kg size 2, 100 kg size 3

Minimum information (Without this information your order can not be handled.)

Frame colour

Seat width in cm 30 32 34 36 38 40 42 44

Camber 3° (3282-1220) 6° (3282-1230) 9° (3282-1240)

Presettings

Seat angle	0° - 10°	Seat height *	<input type="checkbox"/> (36 - 51 cm)
Seat depth (SD) **	<input type="checkbox"/> (23 - 49 cm)	Lower Leg Length (LLL) ***	<input type="checkbox"/> (16 - 46 cm)
Backrest angle	<input type="checkbox"/> 70° <input type="checkbox"/> 75° <input type="checkbox"/> 80° <input type="checkbox"/> 85° <input type="checkbox"/> 90° <input type="checkbox"/> 95° <input type="checkbox"/> 100° <input type="checkbox"/> 105° <input type="checkbox"/> 110° <input type="checkbox"/> 115°		
Backrest height	<input type="checkbox"/> (20 - 35 cm) partly only with telescopic tubes/single push handle	AD	<input type="checkbox"/> (0 - 10 cm)

* see table "Seat height"

** Possible SD frame size 1: 19 - 34 cm; size 2: 20 - 39 cm; size 3: 25 - 44 cm, see table "Seat depth"

*** Possible LLL frame size see table „Lower leg length“

At missing specifications, we will adjust to:

SD = SW, seat angle = 4°, seat height = mid dimension, LLL = seat depth, back height = minimum, back angle = 90°, active degree = 3 rear wheel: **HOGGI** light with aluminium design rim, push rim mounting "standard", front wheel: wheel with rubber tire

Basic variation

with/or: Please select only one version! SW=Seat width

	Orderno.	Colour	Description	Qty.	Price	€
	<input type="checkbox"/> 3281-00SW		SUPRA 2.0 size 1, SD 23 - 39 cm	1 pc.		
with	<input type="checkbox"/> 3284-22SW	320	Seat cover size 1	01	1 set	incl.
or	<input type="checkbox"/> 3281-23SW	052	Seat panel, size 1	02	1 set	incl.
	<input type="checkbox"/> 3282-00SW		SUPRA 2.0 size 2, SD 24 - 44 cm	1 pc.		
with	<input type="checkbox"/> 3285-22SW	320	Seat cover size 2	01	1 set	incl.
or	<input type="checkbox"/> 3282-23SW	052	Seat panel, size 2	02	1 set	incl.
	<input type="checkbox"/> 3283-00SW		SUPRA 2.0 size 3, SD 29 - 49 cm	1 pc.		
with	<input type="checkbox"/> 3286-22SW	320	Seat cover size 3	01	1 set	incl.
or	<input type="checkbox"/> 3283-23SW	052	Seat panel, size 3	02	1 set	incl.
or	<input type="checkbox"/> 3281-2299		Without seat cover		1 set	
with	<input type="checkbox"/> 3281-35SW	000	Back rest frame, back height 20 cm	03	1 set	incl.
or	<input type="checkbox"/> 3281-36SW	000	Back rest frame, back height 25 cm		1 set	incl.
or	<input type="checkbox"/> 3281-37SW	000	Back rest frame, back height 30 cm		1 set	incl.
or	<input type="checkbox"/> 3281-38SW	000	Back rest frame, back height 35 cm		1 set	incl.
with	<input type="checkbox"/> 3281-24SW	320	Adaptable back cover back height 20 - 25 cm	04	1 set	incl.
or	<input type="checkbox"/> 3281-25SW	320	Adaptable back cover back height 25 - 35 cm		1 set	incl.
or	<input type="checkbox"/> 3281-26SW	320	Adaptable back cover back height 30 - 40 cm		1 set	incl.
or	<input type="checkbox"/> 3281-27SW	320	Adaptable back cover back height 35 - 40 cm		1 set	incl.
			* Height adjustment only with 3251-2175 or 3261-5102			
or	<input type="checkbox"/> 3282-52SW	000	Back panel in frame colour, back height 25 (max. SW 36)	05	1 set	incl.
or	<input type="checkbox"/> 3282-53SW	000	Back panel in frame colour, back height 30		1 set	incl.
or	<input type="checkbox"/> 3282-54SW	000	Back panel in frame colour, back height 35		1 set	incl.
or	<input type="checkbox"/> 3282-55SW	000	Back panel in frame colour, back height 40 (with back rest frame BH 35)		1 set	incl.
or	<input type="checkbox"/> 3281-2499		Without adaptable back cover or back panel		1 set	
with	<input type="checkbox"/> 3251-2175		Telescopic tubes for back rest height adjustment (from BH 25)	06	1 set	
or	<input type="checkbox"/> 3261-5102		Single push handle for back rest height adjustment (from BH 25)	07	1 set	
			* single push handles are plugged into the back rest frame tubes			
or	<input type="checkbox"/> 3281-5201		Standard single push handles 90°, size 1	08	1 set	
or	<input type="checkbox"/> 3281-5202		Standard single push handles 90°, size 2		1 set	
or	<input type="checkbox"/> 3281-55SW		Push bar SUPRA 2.0	09	1 pc.	
or	<input type="checkbox"/> 3281-58SW		Push bar "wide" SUPRA 2.0	10	1 pc.	
or	<input type="checkbox"/> 3281-53SW		Push-handles SUPRA 2.0	11	1 set	
or	<input type="checkbox"/> 3281-5200		Push handles displaced to the back, height adjustable	12	1 set	
or	<input type="checkbox"/> 3281-5203		Single push handles, foldable	13	1 pc	
or	<input type="checkbox"/> 3275-5502		One hand push-handle delta form (max. SW 36)	14	1 pc.	
with	<input type="checkbox"/> 3281-3401		Back rest fixed	15	1 set	incl.
or	<input type="checkbox"/> 3281-34SW		Back rest frame with additional relax position (15°) Retractable and lockable in transport position	16	1 set	
with	<input type="checkbox"/> 3281-7300		Tie down kit according to ISO 7176-19	(upcharge) 17	1 set	
with	<input type="checkbox"/> 3274-7301		Back rest extension (only with back panel)	18	1 set	
with	<input type="checkbox"/> 3274-7370	346	Cushion for back rest extension, black check	19	1 pc.	
			* If there is no shoulder and head support mounted in the handicapped transport vehicle, SUPRA 2.0 needs a back panel and back extension.			
with	<input type="checkbox"/> 3281-47SW		Tube frame footrest (standard)	20	1 pc	incl.
or	<input type="checkbox"/> 3281-41SW		Footrest one piece aluminium footplate, angle adjustable	(upcharge) 21	1 set	
or	<input type="checkbox"/> 3281-40SW		Footrest one piece aluminium footplate, fold backwards	(upcharge) 22	1 set	
or	<input type="checkbox"/> 3281-46SW		Footrest one piece aluminium footplate, angle adjustable, for short LLL reduced by 11 cm*	(upcharge) 23	1 set	
or	<input type="checkbox"/> 3281-48SW		Footrest one piece aluminium footplate, angle adjustable, for short LLL reduced by 7 cm*	(upcharge)	1 set	
or	<input type="checkbox"/> 3281-43SW		Footrest one piece aluminium footplate, angle adjustable, foldable	(upcharge) 24	1 set	
or	<input type="checkbox"/> 3281-45SW		Single foot plate footrest, angle adjustable, foldable	(upcharge) 25	1 pair	
			*only to SW 38			

Brakes, fender

with/or: Please select only one version!

	Orderno.	Colour Description	Qty.	Price €
with	<input type="checkbox"/> 3281-1750	HOGGI light sport brake	26 1 set	incl.
or	<input type="checkbox"/> 3282-1700	Standard brakes SUPRA 2.0	1 set	incl.
with	<input type="checkbox"/> 3283-1610	Standard side guards suitable for frame size 1	1 pair	incl.
or	<input type="checkbox"/> 3283-1630	Standard side guards suitable for frame size 2+3 (SH 38-45)	27 1 pair	incl.
or	<input type="checkbox"/> 3283-1640	Standard side guards suitable for frame size 2+3 (SH 44-52)	28 1 pair	incl.
or	<input type="checkbox"/> 3283-1650	Standard side guards with armrests suitable for frame size 1 (upcharge)	1 pair	
or	<input type="checkbox"/> 3283-1670	Standard side guards with armrests suitable for frame size 2+3 (SH 38-45) (upcharge)	29 1 pair	
or	<input type="checkbox"/> 3283-1680	Standard side guards with armrests suitable for frame size 2+3 (SH 44-52) (upcharge)	30 1 pair	
with	<input type="checkbox"/> 3282-160x	Side guards plane in frame colour (0=20", 2=22", 4=24") (upcharge)	1 pair	
or	<input type="checkbox"/> 3283-160x	Side guards plane in fr. colour with armrests (0=20", 2=22", 4=24") (upcharge)	31 1 pair	
with	<input type="checkbox"/> 7000-0051	PU-Armrest pads, 235 mm long	1 pair	incl.
or	<input type="checkbox"/> 7000-0052	PU-Armrest pads, 270 mm long	1 pair	incl.
or	<input type="checkbox"/> 3282-165y-000	Wheel guards aluminum in frame colours, 20-24" mounting: <input type="checkbox"/> fixed <input type="checkbox"/> detachable (upcharge)	32 1 set	
or	<input type="checkbox"/> 3282-166y-000	Wheel guards aluminum in frame colour with integrated wheel lock levers, mounting: fixed (upcharge)	33 1 set	
or	<input type="checkbox"/> 3282-167y-000	Wheel guards aluminum in frame colour with height adjustable, detachable arm rests, 20-24" mounting: <input type="checkbox"/> fixed <input type="checkbox"/> detachable (upcharge)	34 1 set	
or	<input type="checkbox"/> 3282-168y-000	Wheel guards aluminum in frame colour with integrated wheel lock levers, height adjustable, detachable arm rests, 20-24", mounting: fixed (upcharge)	35 1 set	
with	<input type="checkbox"/> 7000-0051	PU-Armrest pads, 235 mm long	1 pair	incl.
or	<input type="checkbox"/> 7000-0052	PU-Armrest pads, 270 mm long	1 pair	incl.
	<input type="checkbox"/> 3240-8202	Therapy tray size 2, SW 24 and 26 cm *	36 1 pc.	
	<input type="checkbox"/> 3240-8203	Therapy tray size 3, SW 28, 30 and 32 cm *	1 pc.	
	<input type="checkbox"/> 3240-8204	Therapy tray size 4, SW 34, 36 and 38 cm *	1 pc.	
	<input type="checkbox"/> 3240-8205	Therapy tray size 5, SW 40, 42 and 44 cm *	1 pc.	

* only in combination with armrests

Rear wheels

with/or: Please select only one version!

	Orderno.	Colour Description	Qty.	Price €
with	<input type="checkbox"/> 1293-0xxx	Rear wheel HOGGI light	1 set	incl.
or	<input type="checkbox"/> 1293-2xxx	Rear wheel HOGGI light with drum brakes* (upcharge)	1 set	
		* in combination with push-bar or push-handles only		
with	<input type="checkbox"/> 1293-x2xx	20" wheel diameter	1 set	incl.
or	<input type="checkbox"/> 1293-x3xx	22" wheel diameter	1 set	incl.
or	<input type="checkbox"/> 1293-x4xx	24" wheel diameter	1 set	incl.
with	<input type="checkbox"/> 1293-xx1x	Pneumatic tires 1"	37 1 set	incl.
or	<input type="checkbox"/> 1293-xx2x	Flat free tires (20x1 3/8", 22x1" and 24x1")	38 1 set	incl.
with	<input type="checkbox"/> 1293-xxx0	Without push-rims		
or	<input type="checkbox"/> 1293-xxx1	Push rims aluminium anodised, "standard" mounting	39 1 set	incl.
or	<input type="checkbox"/> 1293-xxx2	Push rims aluminium anodised, "high" mounting	40 1 set	incl.
or	<input type="checkbox"/> 1293-xxx3	Push rims stainless steel, "standard" mounting (upcharge)	41 1 set	
or	<input type="checkbox"/> 1293-xxx4	Push rims stainless steel, "high" mounting (upcharge)	42 1 set	
with		<input type="checkbox"/> Push-rim mounting "narrow"		
or		<input type="checkbox"/> Push-rim mounting "wide"		
or	<input type="checkbox"/> 1204-1155	Closed ergonomic hand rims 22 ", black anodized, for Hoggi-light wheels (Upcharge)	70 1 Set	
or	<input type="checkbox"/> 1204-1156	Closed ergonomic hand rims 24 ", black anodized, for Hoggi-light wheels (Upcharge)	1 Set	
with	<input type="checkbox"/> 1204-106X	"HOGGI Grip Plus" hand rim inserts black, for closed ergonomic hand rims (Upcharge)	71 1 Set	

Rear wheels

with/or: Please select only one version!

	Orderno.	Colour	Description	Qty.	Price €
<input type="checkbox"/>	1204-114X		Aluminum hand rim with plastic anti-slip coating, black, standard mounting *	(Upcharge) 72	1 pair
<input type="checkbox"/>	1204-114X		Aluminum hand rim with plastic anti-slip coating, black, high mounting *	(Upcharge)	1 pair
* only in combination with HOGGI light rear wheels					
or	<input type="checkbox"/>	1296-4211	Pneumatic wheel 20x1" HOGGI Extra light *	(upcharge) 43	1 set
or	<input type="checkbox"/>	1296-4311	Pneumatic wheel 22x1" HOGGI Extra light *	(upcharge)	1 set
or	<input type="checkbox"/>	1296-4411	Pneumatic wheel 24x1" HOGGI Extra light *	(upcharge)	1 set
* incl. black alu push-rim					

Spoke guards // Old motifs // Sale

	Order no.	Colour	Description	Qty.	Price €
<input type="checkbox"/>	1204-101x		Spoke guard, transparent *	44	1 set
<input type="checkbox"/>	1204-101x		Spoke guard, transparent, for drum brakes wheels *		1 set
<input type="checkbox"/>	1204-101x		Spoke guard, printed **	(Sale) 45	1 set
<input type="checkbox"/>	1204-101x		Spoke guard, printed, for drum brakes **	(Sale)	1 set
* Motifs 2021 only possible in combination with 1204-2001-XXX					
** please enter code of your print design see attachment or brochure "spoke guard" // Only while stocks last!					
*** printed spoke guards are not available for 20" wheels					

Spoke guards // New motifs 2021 (with 10% dealer discount)

	Order no.	Colour	Description	Qty.	Price €
<input type="checkbox"/>	1204-2001-000		Spoke guard Special interior foiling, single-coloured according to customer requirements ^{1 2}		1 set
<input type="checkbox"/>	1204-2001-2XX		Spoke guard Special interior foiling, printed ^{1 3}		1 set
<input type="checkbox"/>	1204-2001-SA		Spoke guard Special interior foiling, printed according to customer requirements ¹		Price on request
¹ only in combination with transparent spoke guard					
² please specify RAL tone					
³ Spoke guard motif selectable in "Order form spoke-guards" (available on the website)					

Front castors

with/or: Please select only one version!

	Orderno.	Colour	Description	Qty.	Price €
with	<input type="checkbox"/>	1250-1002	Wheel with rubber tire, black 100 x 32 mm	46	1 set incl.
or	<input type="checkbox"/>	1250-1003	Wheel with rubber tire, black 125 x 32 mm		1 set incl.
or	<input type="checkbox"/>	1250-1005	Wheel with rubber tire, black 140 x 40 mm		1 set incl.
or	<input type="checkbox"/>	1249-1005	Skater wheel with LED 100 x 24 mm	(upcharge) 47	1 set
or	<input type="checkbox"/>	1249-1006	Skater wheel with LED 125 x 24 mm	(upcharge)	1 set
or	<input type="checkbox"/>	1221-1003	PU-wheel with plastic design rim 100 x 34 mm	(upcharge) 48	1 set
or	<input type="checkbox"/>	1221-1004	PU-wheel with plastic design rim 125 x 34 mm	(upcharge)	1 set

Accessories

SW=Seat width

	Orderno.	Colour	Description	Qty.	Price €
<input type="checkbox"/>	3281-880x	346	Calf strap SUPRA 2.0 with upholstery, black	49	1 set
<input type="checkbox"/>	3281-1901		SUPRA 2.0 Anti tip 20", swing away, left	50	1 pc.
<input type="checkbox"/>	3281-1902		SUPRA 2.0 Anti tip 20", swing away, right		1 pc.
<input type="checkbox"/>	3282-1901		SUPRA 2.0 Anti tip 22 + 24", swing away, left		1 pc.
<input type="checkbox"/>	3282-1902		SUPRA 2.0 Anti tip 22 + 24", swing away, right		1 pc.
<input type="checkbox"/>	3281-190x		Tip assist, left <input type="checkbox"/> =3 or right <input type="checkbox"/> =4	51	1 pc.
<input type="checkbox"/>	3251-71SW	346	Seat cushion; 3 cm thick, size 1	52	1 pc.
<input type="checkbox"/>	3252-71SW	346	Seat cushion; 3 cm thick, size 2		1 pc.
<input type="checkbox"/>	3253-71SW	346	Seat cushion; 3 cm thick, size 3		1 pc.
<input type="checkbox"/>	3276-7100	346	Back cushion for back panle, 2,5 cm thick (SB und RH)	53	1 pc.

Accessories				SW=Seat width	
	Orderno.	Colour	Description	Qty.	Price €
with	<input type="checkbox"/>	2240-1505	MDP pad holder swing away and detachable for attachment to round tube D25 mm, left side	54	1 pc.
with	<input type="checkbox"/>	2240-1506	MDP pad holder swing away and detachable for attachment to round tube D25 mm, right side		1 pc.
or	<input type="checkbox"/>	2240-1405	MDP pad holder fixed for attachment to round tube D25 mm, left/right side	55	1 pc.
with	<input type="checkbox"/>	2240-1461	346 MDP trunk support size 1 (8 x 10 x 2 cm), cover black	56	1 pc.
or	<input type="checkbox"/>	2240-1462	346 MDP trunk support size 2 (10 x 12 x 2 cm), cover black		1 pc.
or	<input type="checkbox"/>	2240-1463	346 MDP trunk support size 3 (12 x 13 x 2 cm), cover black		1 pc.
or	<input type="checkbox"/>	2240-1471	MDP trunk support curved size 1 (6 x 11,5 x 2,5 cm), PU w/o cover	57	1 pc.
or	<input type="checkbox"/>	2240-1472	MDP trunk support curved size 2 (8 x 14 x 2,5 cm), PU w/o cover		1 pc.
	<input type="checkbox"/>	3201-3830	Universal headrest bracket (for 3245-7800 or third-party products) *	58	1 pc.
	<input type="checkbox"/>	3245-7800	306 Headrest with occiput upholstery	59	1 pc.
* starting from backrest height 30 cm					
	<input type="checkbox"/>	3200-0401	Belt routing as a T-strap above the shoulders	60	1 pc.
	<input type="checkbox"/>	3251-77SW	Nylon back cover (to cover the straps of the adaptable back cover)	61	1 pc.
	<input type="checkbox"/>	3251-7600	Edge protector for back rest tubes and telescopic tubes	62	1 set
	<input type="checkbox"/>	1204-101x	Push-rim cover, silicone black fluted	63	1 set
	<input type="checkbox"/>	3281-6100	Lap belt	64	1 pc.
	<input type="checkbox"/>	3201-6400	Ankle hugger, size 1	65	1 pair
	<input type="checkbox"/>	3203-6400	Ankle hugger, size 2		1 pair
	<input type="checkbox"/>	3220-6702	4-Point lap belt, size S (SW 24 - 30)	66	1 pc.
	<input type="checkbox"/>	3220-6703	4-Point lap belt, size M (SW 28 - 36)		1 pc.
	<input type="checkbox"/>	3220-6704	4-Point lap belt, size L (SW 34 - 42)		1 pc.
	<input type="checkbox"/>	3231-7800	346 Abduction block size 1, swing away, detachable, (9 x 6 x 9 cm) *	67	1 set
	<input type="checkbox"/>	3231-7900	346 Abduction block size 2 swing away, detachable, (11 x 8 x 10 cm) *		1 set
	<input type="checkbox"/>	3233-7800	346 Abduction block size 3 swing away, detachable, (12 x 9 x 10 cm) *		1 set
* only with seat panel 328X-23SW					

Custom-made				SW=Seat width	
	Orderno.	Colour	Description	Qty.	Price €
	<input type="checkbox"/>	3281-80SW	346 Contoured seat cushion with cover, black, SW 24 - 32	68	1 pc.
	<input type="checkbox"/>	3281-80SW	346 Contoured seat cushion with cover, black, SW 34 - 44		1 pc.
	<input type="checkbox"/>	3275-7200	346 "HOGGI align" Contoured back cushion, black	69	1 pc.
	<input type="checkbox"/>	SA-0286/2-KP	Abduction block 30 mm height extension kit *		1 set
* only in combination with abduction block and contoured seat cushion					
	<input type="checkbox"/>	6999-0014	060 Special Frame colour, Copper Gold (Upcharge)		1 pc.
	<input type="checkbox"/>	6999-0021/1	Castor forks powder coated according to customer requirements * (no glitter) (Upcharge)		1 set
	<input type="checkbox"/>	6999-0021/2	Back retainer plates powder coated, color according to customer specification (Upcharge)		1 set
	<input type="checkbox"/>	6999-0021/3	Alu-wheel guards powder coated, color according to customer specification (Upcharge)		1 set
	<input type="checkbox"/>	SA-0390	Upholstery in special colour *		Price on request
* please enter colour code or upholstery code respectively					
	<input type="checkbox"/>	SA-0572-F-MP	Plastic anti-slip coating in custom colour: Pure white (RAL 9010), Silver grey (RAL 7001), Sky blue (RAL 5015), Traffic red (RAL 3020), Pure orange (RAL 2004)* (Upcharge)	73	1 pair
* only in combination with HOGGI light rear wheels					
	<input type="checkbox"/>	SA-0093-MP	Maxgrepp Original cell rubber coated push rims (Upcharge)	74	1 set
	<input type="checkbox"/>	SA-0094-MP	Maxgrepp Ergo Para (closed push rims) (Upcharge)	75	1 set
	<input type="checkbox"/>	SA-0095-MP	Maxgrepp Ergo Para CP (advanced closed push rims) (Upcharge)	76	1 set
	<input type="checkbox"/>	SA-0210	Special Frame colour, RAL code only (Upcharge)		1 pc.
	<input type="checkbox"/>	SA-0505-MP	Locking of the integrated brake	77	1 pc.
	<input type="checkbox"/>	SA-0594	Carbon wheel cover (Upcharge)	78	Price on request

Upholstery colours

346	Black	321	Spacer fabric, black (special colour)	348	Grey Soft (special colour)
		347	Berry Soft (special colour)	349	Turquoise Soft (special colour)

All HOGGI upholstery are made from flame retardant Trevira CS. Exception spacer fabric (321).

Seat height front

SUPRA 2.0 Seat height front																			
Frame size	Seat angle	short front fork, castors pos. 1281-1023									long front fork, castors pos. 1281-1026								
		100			125			140			100			125			140		
		1	2	3	1	2	3	1	2	3	2	3	4	2	3	4	2	3	4
1	0°	38	39	41	39	41	42	40	41	43	41	42	43	42	43	44	43	44	45
	4°	38	39	40	39	40	41	40	41	42	40	41	43	41	43	44	42	43	45
	7°	37	38	39	38	39	41	39	40	41	39	41	42	41	42	43	41	43	44
	10°	36	37	39	37	39	40	38	39	41	39	40	41	40	41	42	41	42	43
2	0°	40	41	43	41	43	44	42	43	45	43	44	45	44	45	46	45	46	47
	4°	40	41	42	41	42	43	42	43	44	42	43	45	43	45	46	44	45	47
	7°	39	40	41	40	41	43	41	42	43	41	43	44	43	44	45	43	45	46
	10°	38	39	41	39	41	42	40	41	43	41	42	43	42	43	44	43	44	45
3	0°	45	46	48	46	48	49	47	48	50	48	49	50	49	50	51	50	51	52
	4°	44	46	47	46	47	48	46	48	49	47	48	49	48	49	51	49	50	51
	7°	44	45	46	45	46	47	46	47	48	46	47	49	47	49	50	48	49	51
	10°	43	44	45	44	45	47	45	46	47	45	47	48	47	48	49	47	49	50

(Measured at front edge of seat cover ± 0,5 cm)

Lower Leg Length

SUPRA 2.0 Abdu / SUPRA 2.0 Seat height and Lower Leg Length according to frame size								
size	SH (at 4° seat angle)	Footrests						
		3294-47SB 3281-47SB Tube frame footrest	3294-41SB 3281-41SB Footrest one piece aluminium footplate, angle adjustable	3294-46SB 3281-46SB Footrest one piece aluminium footplate, angle adjustable for short LLL reduced by 11 cm	3294-48SB 3281-48SB Footrest one piece aluminium footplate, angle adjustable for short LLL reduced by 7 cm	3294-43SB 3281-43SB Footrest one piece aluminium footplate, angle adjustable, foldable	3294-45SB 3281-45SB Single foot plate footrest, angle adjustable, foldable	3294-40SB 3281-40SB Footrest one piece aluminium footplate, fold backwards
SUPRA 2.0 Frame size 1	38	28 - 34	28 - 34	16 - 23	20 - 26	28 - 34	28 - 34	28 - 35
	39	28 - 35	28 - 35	16 - 24	20 - 27	28 - 35	28 - 35	28 - 36
	40	28 - 36	28 - 36	16 - 25	20 - 28	28 - 36	28 - 36	28 - 37
	41	28 - 37	28 - 37	16 - 26	20 - 29	28 - 37	28 - 37	28 - 38
	42	28 - 38	28 - 38	16 - 27	20 - 30	28 - 38	28 - 38	28 - 39
	43	28 - 39	28 - 39	16 - 28	20 - 31	28 - 39	28 - 39	28 - 40
	44	28 - 40	28 - 40	16 - 29	20 - 32	28 - 40	28 - 40	28 - 41
SUPRA 2.0 Frame size 2	40	30 - 34	30 - 34	19 - 24	23 - 27	30 - 34	30 - 34	30 - 35
	41	30 - 35	30 - 35	19 - 25	23 - 28	30 - 35	30 - 35	30 - 36
	42	30 - 36	30 - 36	19 - 26	23 - 29	30 - 36	30 - 36	30 - 37
	43	30 - 37	30 - 37	19 - 27	23 - 30	30 - 37	30 - 37	30 - 38
	44	30 - 38	30 - 38	19 - 28	23 - 31	30 - 38	30 - 38	30 - 39
	45	30 - 39	30 - 39	19 - 29	23 - 32	30 - 39	30 - 39	30 - 40
	46	30 - 40	30 - 40	19 - 30	23 - 33	30 - 40	30 - 40	30 - 41
SUPRA 2.0 Frame size 3	44	34 - 40	34 - 40	23 - 28	27 - 32	34 - 40	34 - 40	34 - 41
	45	34 - 41	34 - 41	23 - 29	27 - 33	34 - 41	34 - 41	34 - 42
	46	34 - 42	34 - 42	23 - 30	27 - 34	34 - 42	34 - 42	34 - 43
	47	34 - 43	34 - 43	23 - 31	27 - 35	34 - 43	34 - 43	34 - 44
	48	34 - 44	34 - 44	23 - 32	27 - 36	34 - 44	34 - 44	34 - 45
	49	34 - 45	34 - 45	23 - 33	27 - 37	34 - 45	34 - 45	34 - 46
	50	34 - 46	34 - 46	23 - 34	27 - 38	34 - 46	34 - 46	34 - 47
51	34 - 46	34 - 46	23 - 35	27 - 39	34 - 46	34 - 46	34 - 47	

Seat depth range according to active degree

SUPRA 2.0 Seat depth range (front castor Ø100 and seat angle 5° or less)													
Wheel size 20"				Wheel size 22"						Wheel size 24"			
AD	Frame size			AD	Frame size			AD	Frame size				
	Gr.1	Gr.2	Gr.3		Gr.1	Gr.2	Gr.3		Gr.2	Gr.3			
0	23-29	24-34		0	25-29	25-34	29-39	0	28-34	29-39			
1	24-30	25-35		1	26-30	26-35	30-40	1	29-35	30-40			
2	25-31	26-36		2	27-31	27-36	31-41	2	30-36	31-41			
3	26-32	27-37		3	28-32	28-37	32-42	3	31-37	32-42			
4	27-33	28-38		4	29-33	29-38	33-43	4	32-38	33-43			
5	28-34	29-39		5	30-34	30-39	34-44	5	33-39	34-44			
6	29-35	30-40		6	31-35	31-40	35-45	6	34-40	35-45			
7	30-36	31-41		7	32-36	32-41	36-46	7	35-41	36-46			
8	31-37	32-42		8	33-37	33-42	37-47	8	36-42	37-47			
9	32-38	33-43		9	34-38	34-43	38-48	9	37-43	38-48			
10	33-39	34-44		10	35-39	35-44	39-49	10	38-44	39-49			

Dependent on castor Ø bigger than 100mm and seat angle beyond 5° minimum seat depth might not be reached

Restriction of the footrest systems

SUPRA 2.0 Footrest systems	Restriction footrest systems*				
	Minimum seat angle			Front castors	
	1°	4°	6°	125	140
Tube frame footrest (standard)	x				x
Footrest one piece aluminium footplate, angle adjustable	x				x
Footrest one piece aluminium footplate, fold backwards	x				x
Footrest one piece aluminium footplate, angle adjustable, for short LLL reduced by 11 cm		x			x
Footrest one piece aluminium footplate, angle adjustable, for short LLL reduced by 7 cm		x			x
Footrest one piece aluminium footplate, angle adjustable, foldable		x			x
Single foot plate footrest, angle adjustable, foldable	x			x	
Single foot plate footrest, angle adjustable, foldable			x		x

* concerns SUPRA 2.0 (SW 30-44) and SUPRA 2.0 Abdu

How to measure and active degree

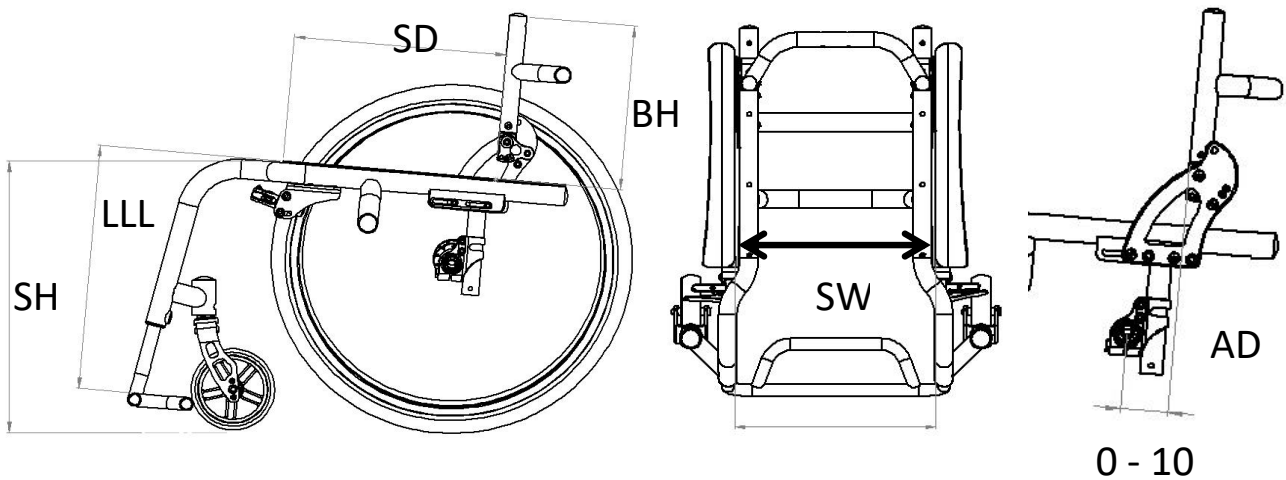

SH = Seat height LLL = Lower leg length SD = Seat depth BH = Back height SW = Seat width AD = Active degree
(All measurements are without seat or back upholstery)

Frame colours

001 Black (RAL 9005)	020 Yellow green (RAL 6018)	028 Pearl violet (RAL 4011)	056 Turquoise blue (RAL 5018)
002 Silver	021 Grey aluminium (RAL 9007)	029 Pearl beige (RAL 1035)	057 Iron sparkling dark light
003 Pearl ruby red (RAL 3032)	022 White (RAL 9003)	032 Black dull matt (RAL 9005M)	058 Salmon orange (RAL 2012)
004 Pearl night blue (RAL 5026)	023 Pure orange (RAL 2004)	039 Signal violet (RAL 4008)	059 Pastel blue (RAL 5024)
005 Pearl gentian blue (RAL 5025)	024 Sparkling iron effect	040 Night blue (RAL 5022)	061 Light pink (RAL 3015)
017 Traffic yellow (RAL 1023)	025 Signal blue (RAL 5005)	050 White matt (RAL 9003)	064 Olive green (RAL 6003)
018 Flame red (RAL 3000)	026 Vermillion (RAL 2002)	053 Light green (RAL 6027)	065 Raspberry red (RAL 3027)
019 Sky blue (RAL 5015)	027 Heather violet (RAL 4003)	054 Ocean blue (RAL 5020)	066 Pastel green (RAL 6019)

SA-0210-MP Special colours on request (Enter RAL code , Upcharge

Spoke guard print design (for detailed images see attachment or brochure "spoke guard")

Colour code

201	HOGGI blue
202	Wonderland
203	Mouse
204	Water world
205	Train
206	Dragon
207	Circus



CONFIGURATIONS // ACCESSORIES // SUPRA 2.0



01 Seat cover



02 Seat panel



03 Back rest frame



04 Adaptable back cover

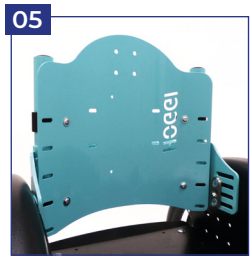

05 Back panel



06 Telescopic tubes



07 Single push handle



08 Single push handles 90°



09 Push bar



10 Push bar „wide“



11 Push-handles



12 Push handles displaced to the back



13 Single push handles, foldable



14 One hand push-handle delta form



15 Back rest fixed



16 Back rest, retractable



17 Tie down kit

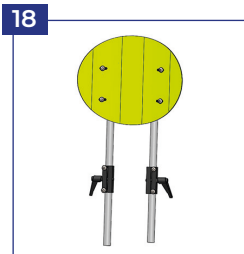

18 Back rest extension

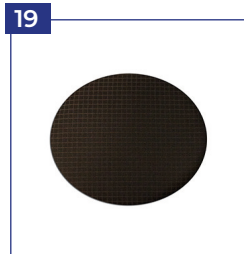

19 Cushion for back rest extension



20 Tube frame footrest



21 Footrest one piece, angle adjustable



22 Footrest one piece, fold backwards



23 Footrest, for short LLL



24 Footrest, foldable



25 Single foot plate footrest



26 HOGGI light sport brake

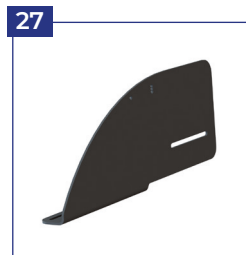

27 Standard side guards

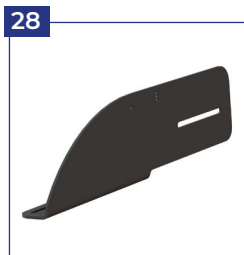

28 Standard side guards



29 Standard side guards with armrests



30 Standard side guards with armrests

CONFIGURATIONS // ACCESSORIES // SUPRA 2.0



31 Side guards plane with armrests

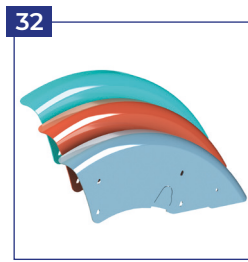

32 Wheel guards aluminum



33 Wheel guards with wheel lock levers



34 Wheel guards, height adjustable, detachable



35 Wheel guards, arm rests, wheel lock levers

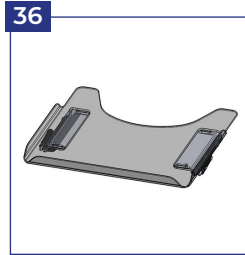

36 Therapy tray



37 Pneumatic tires



38 Pneumatic tires with drum brakes



39 Flat free tires



40 Flat free tires with drum brakes



41 Push rims, standard



42 Push rims, high



43 Push rims stainless steel, standard



44 Push rims stainless steel, high



45 HOGGI Extra light



46 Spoke guard, transparent



47 Spoke guard, printed



48 Wheel with rubber tire



49 Skater wheel



50 PU-wheel with plastic design rim



51 Calf strap



52 Anti tip



53 Tip assist



54 Seat cushion



55 Back cushion



56 MDP pad holder swing away and detachable



57 MDP pad holder fixed

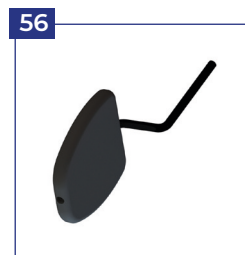

58 MDP trunk support



59 MDP trunk support curved



60 Universal headrest bracket

CONFIGURATIONS // ACCESSORIES // SUPRA 2.0



59 Headrest with occiput upholstery



60 Belt routing as a T-strap



61 Nylon back cover



62 Edge protector



63 Push-rim cover



64 Lap belt



65 Ankle hugger



66 4-Point lap belt



67 Abduction block



68 Contoured seat cushion with cover



69 „HOGGI align“ Contoured back cushion



70 Closed ergonomic hand rims



71 HOGGI Grip Plus



72 Aluminum hand rim with plastic anti-slip coating



73 Aluminum hand rim with plastic anti-slip coating



74 Maxgrepp Original push rims



75 Maxgrepp Ergo Para push rims



76 Maxgrepp Ergo Para CP push rims



77 Locking of the integrated brake



78 Carbon fender